



Teknisk beskrivelse

Easy Living Costa Blanca

mobil: 0047 92 12 86 76

DOSSIER TÉCNICO

v1. Mar24

COCINAS





ENCIMERA

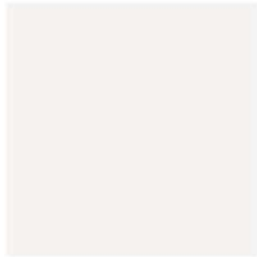

ABSOLUTE BLANC



GRIFERÍA



ELECTRODOMÉSTICOS



BOSCH

BAÑOS





Disobath
bathroom furniture

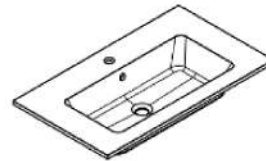
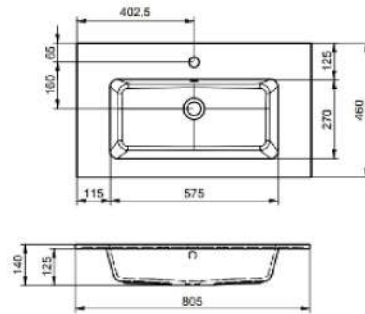

GME

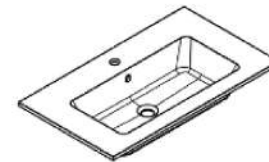
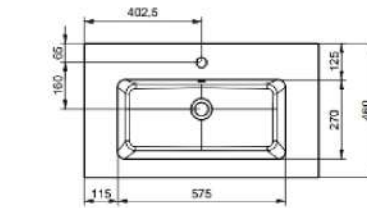

Disobath
bathroom furniture



GRIFERÍA

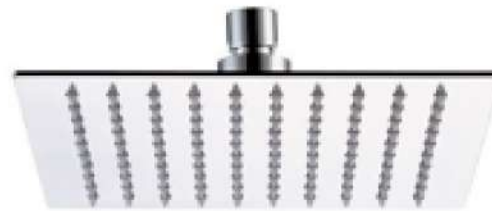

Grifería ecoeficiente
para disminuir el consumo con zona confort.

Rociador de techo de 300x300 efecto lluvia

hansgrohe



LAUFEN

COPENHAGUEN CREAM C1
20X120
TIVOLI CREAM



SERIE: PRO A

INODORO SUSPENDIDO:
Elegante e higiénico

TAPA FINA CON CAIDA AMORTIGUADA
Comodidad y silencio

PULSADOR LIS DOBLE DESCARGA
Diseño y sostenibilidad

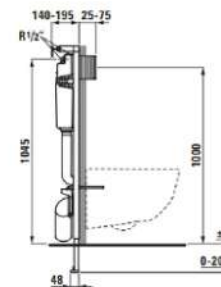
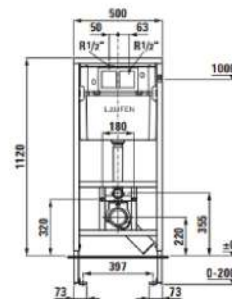
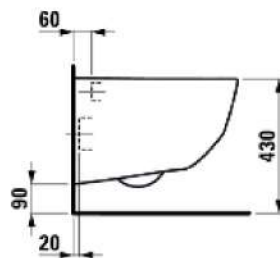
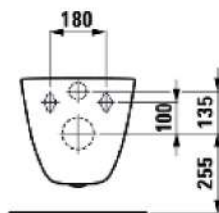
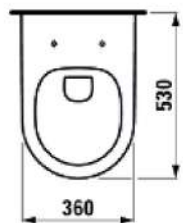

SANITARIOS





CARPINTERIA EXTERIOR



Carpintería exterior de altas prestaciones de asilamiento térmico y acústico y fácil accionamiento. Sistema de vidrios de dos capas securit unidos con butiral acústico y lámina de seguridad separadas por cámara de 16 mm, los diferentes espesores de esta composición de vidrio y cámara rompen la onda acústica y mejoran ampliamente las recomendaciones mínimas de CTE.

deceuninck

Máximo
aislamiento



100%
reciclables



Ahorro
energético



Protección
acústica



Seguridad
y **confort**





El elevador montacoches está diseñado para el traslado vertical de vehículos incluyendo a sus ocupantes y supera en calidad a otros elevadores montacoches por su mayor estabilidad. Ya que el diseño de doble columna le permite soportar más carga y mayores anchos. Estará dotado de mando a distancia para su llegada y apertura y un generador redundante en caso de fallo de suministro eléctrico