

FASADE MOT

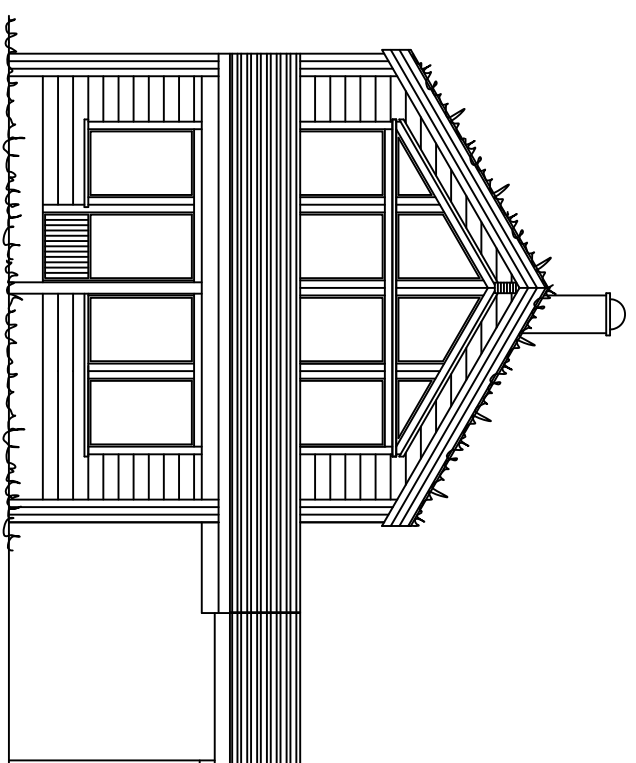

FASADE MOT

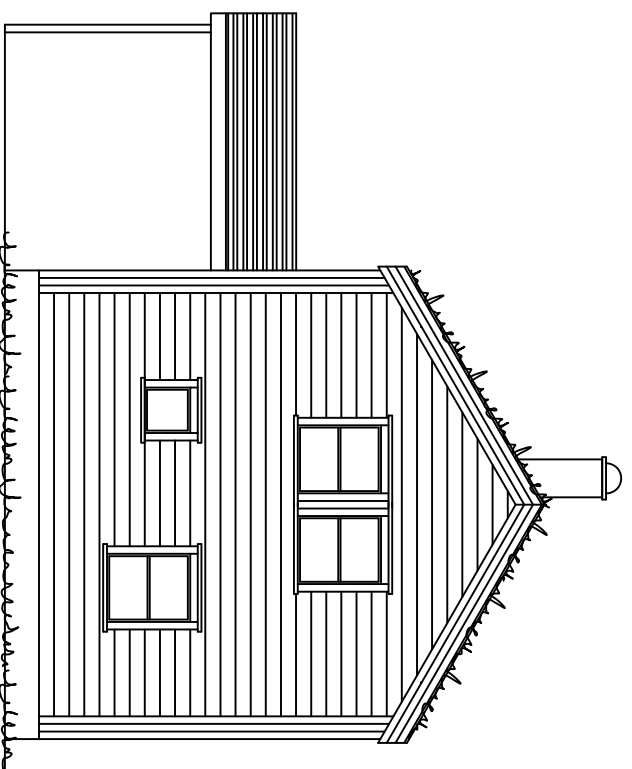

FASADE MOT

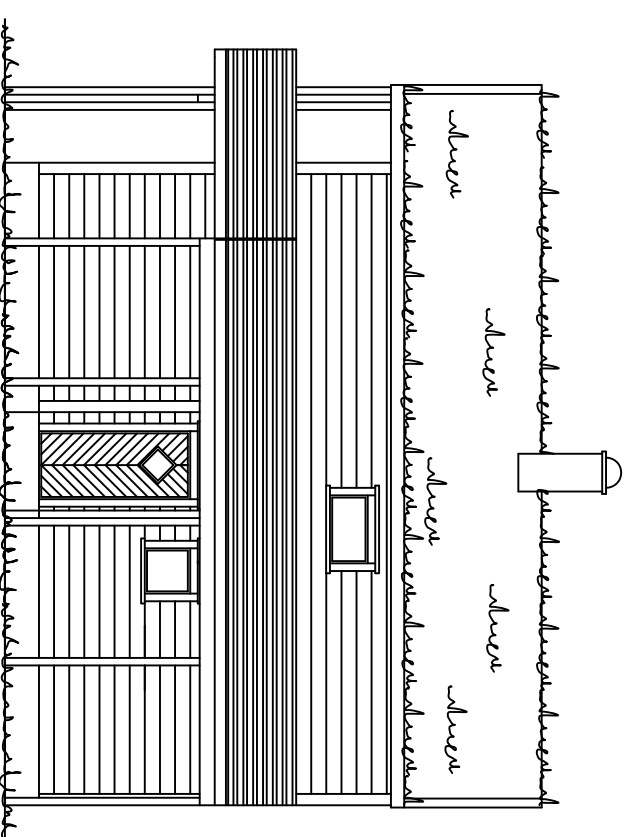

FASADE MOT



4540 ASERAL

Tlf : 38283800 Fax : 38283801

Tlf : Raymond 90752181

Tlf : Eivind 91564829

Mail : raymond@aseralhytter.no

Mail : eivind@aseralhytter.no

Byggherre : Fritidsbygg AS

Prosjekt : Bortelid Fjellgrend tomt 8 seksjon 1

Byggeplass : Bortelid Kommune : Aseral

Type tegning : Fasade Gnr. Bnr : Gnr. 9, Bnr. 558 seksjon 1

Tegningsnr : Målestokk : 1:100

Tegnet av : R. S Dato :

Andre opplysninger :

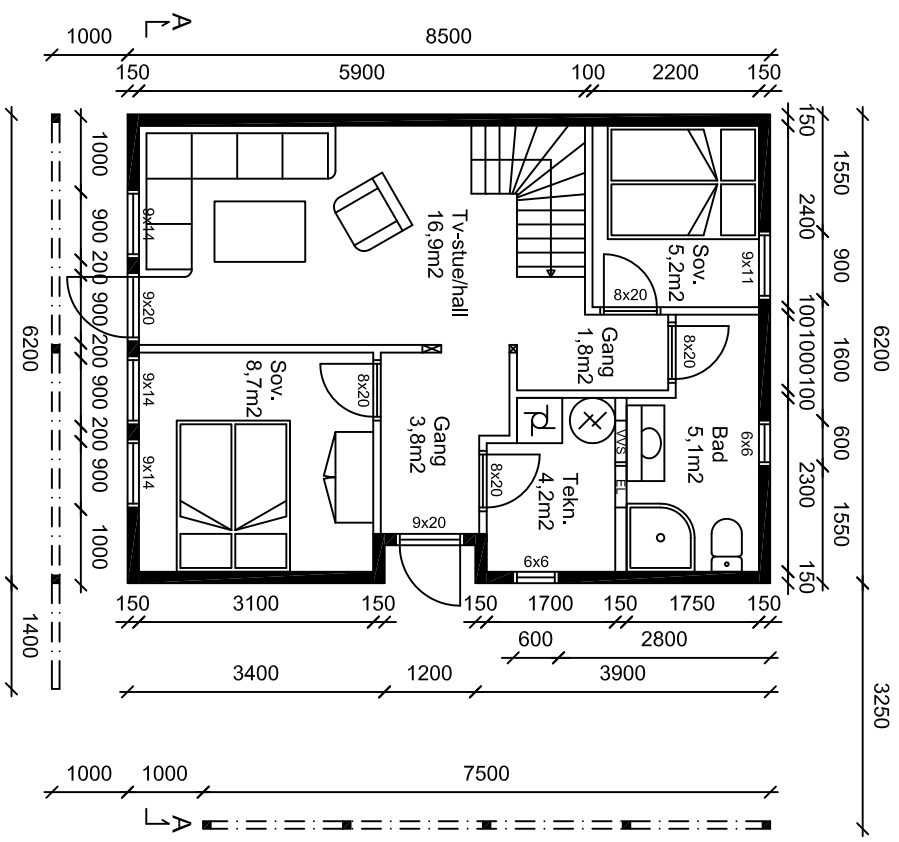

HOVEDPLAN

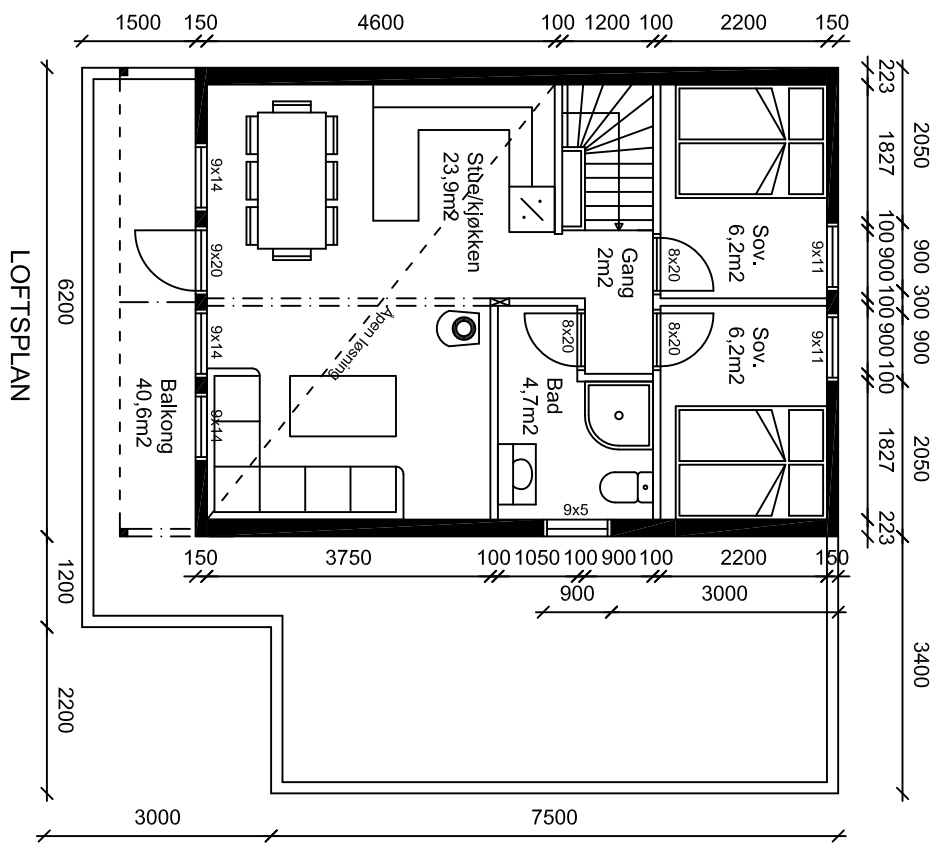

LOFTSPLAN

Grunnflate: 52m<sup>2</sup>  
 BYA: 90,9m<sup>2</sup>  
 BRA: 115,3m<sup>2</sup>

BFG tomtnr. 8 seksj. 1

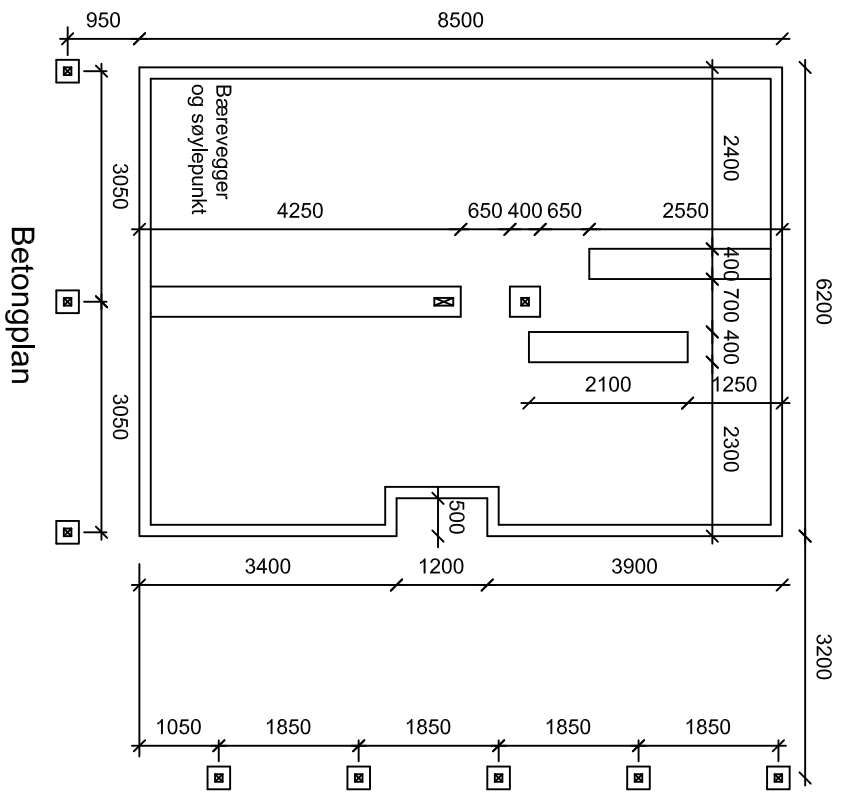

Betongplan

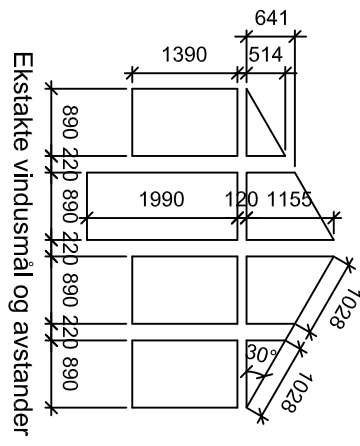
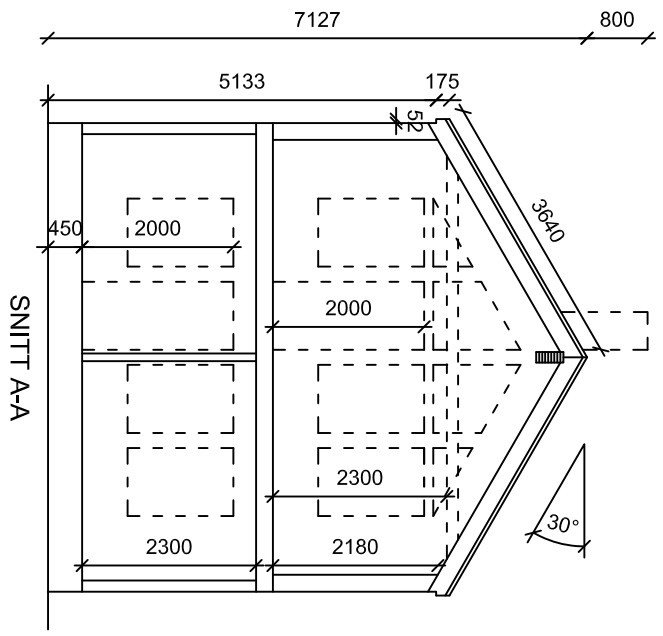

Tegninger må ikke kopieres eller delvis kopieres uten samtykke med Aseral Hytter

	
4540 ASERAL	
Tlf : 38283800 Fax : 38283801	
Tlf : Raymond 90752181	
Tlf : Eivind 91564829	
Mail : raymond@aseralhytter.no	
Mail : eivind@aseralhytter.no	
Byggherre :	Fritidsbygg AS
Prosjekt :	Bortelid Fjellgrend tomt 8 seksjon 1
Byggeplass :	Bortelid
Type tegning :	Plan og snitt
Tegningsnr. :	Gnr. Bnr : Gnr. 9, Bnr. 558 seksjon 1
Tegnet av :	R. S
Andre opplysninger :	Målestokk : 1:100
	Dato :