

Grunnflate: 58,5m<sup>2</sup>  
 BYA: 71,8m<sup>2</sup>  
 BRA: 106m<sup>2</sup>

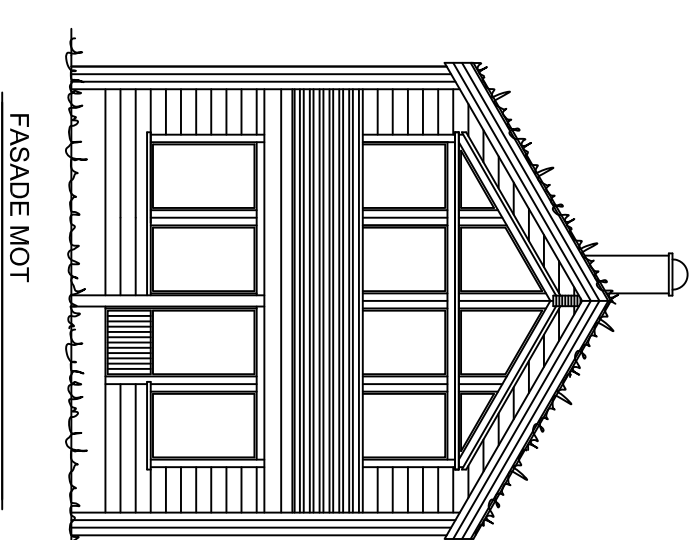
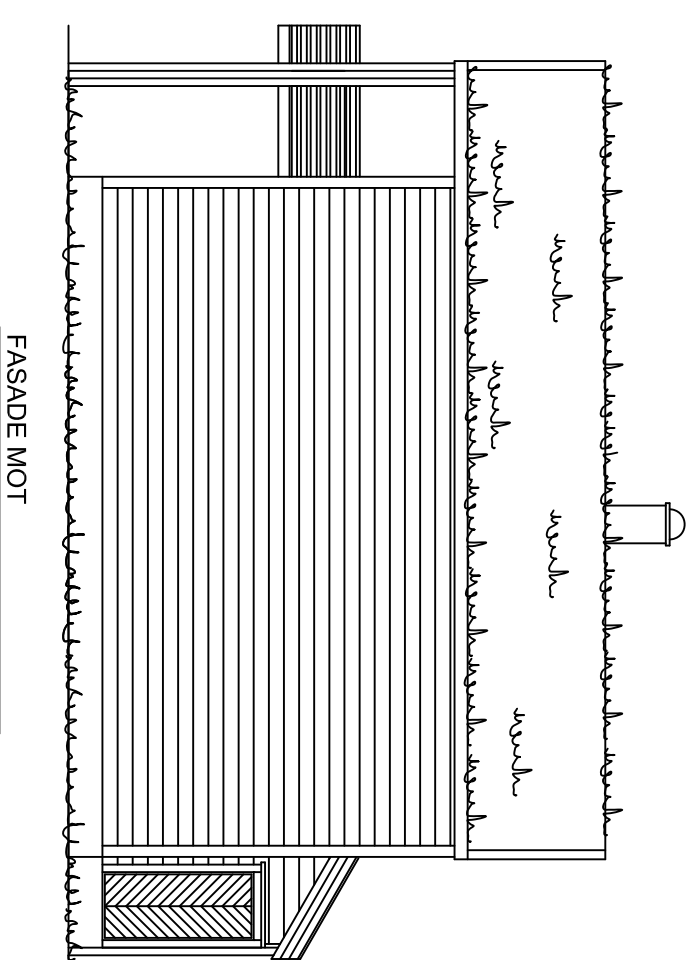
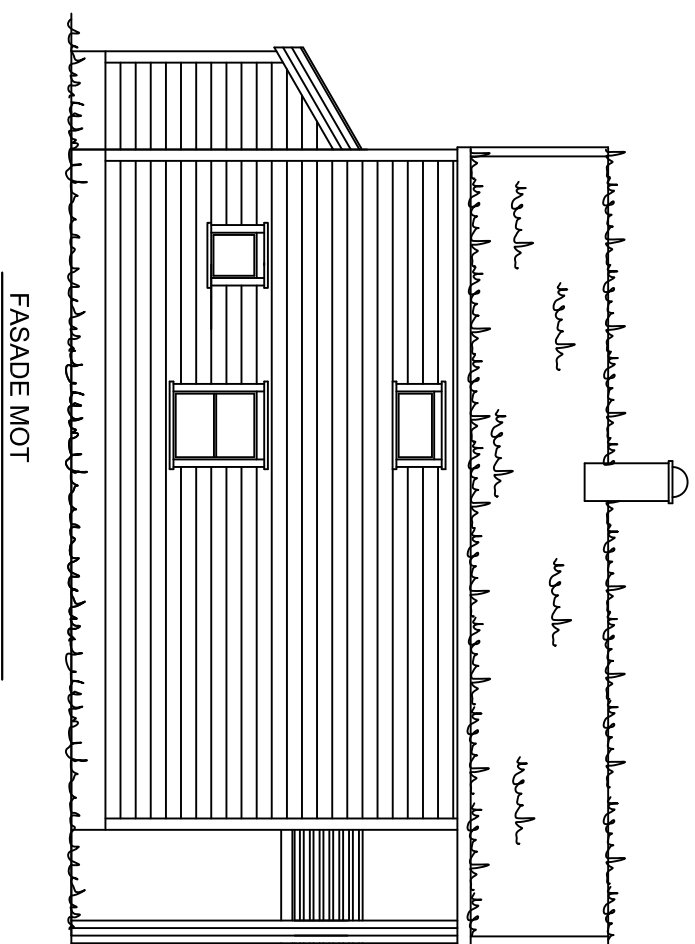
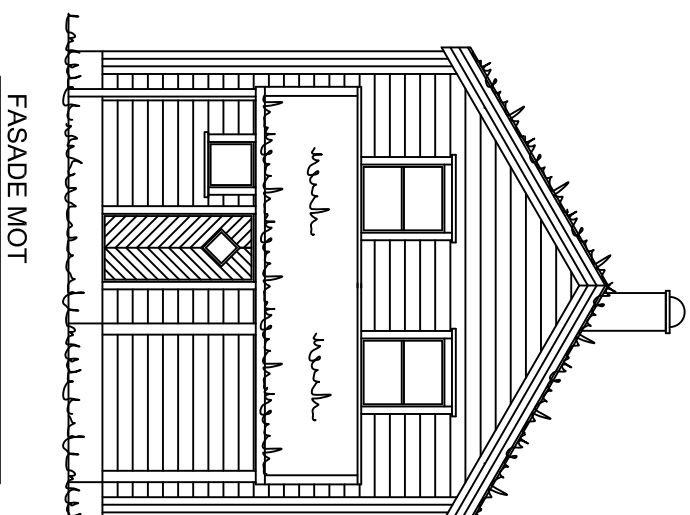
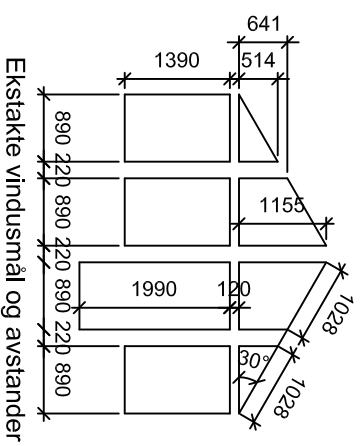
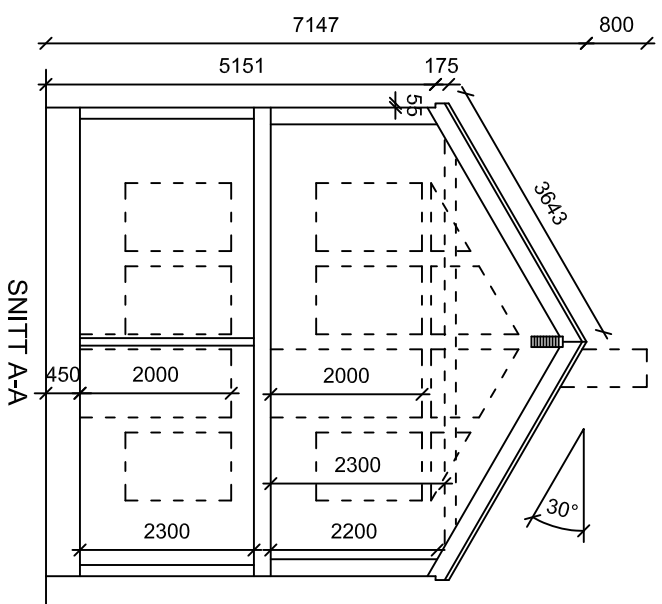
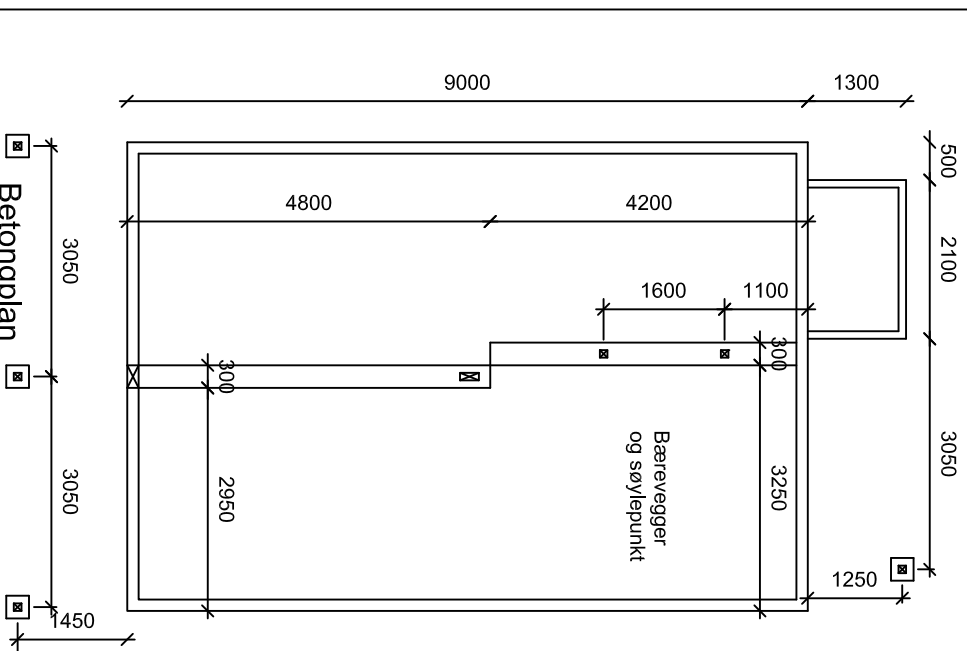

## Seksjon 2

Byggherre:	Fritidsbygg AS
Prosjekt:	BFG tomtr. 19 seksjon 2
Byggeplass:	Bortelid
Type tegning:	Fasader, plan og snitt
Tegningsnr.:	Målestokk: 1:100
Tegnet av:	R. S
Andre opplysninger:	Dato: 04.09.2020
4540 ASERAL Tlf: 38283800 Fax: 38283801 Tlf: Raymond 90752181 Tlf: Eivind 91564829 Mail: raymond@aseralhytter.no Mail: eivind@aseralhytter.no	
Kommune: Aseral	

Tegninger må ikke kopieres eller delvis kopieres uten samtykke med Aseral Hytter