

HOVEDETASJE

REV 15/03-05

Dato	12/01-05	Konstr./Teget	EK/IG	Tracé	Målestokk	1:100
Kontr.	ESKILD	Stend.	kontr.	Godkjent		
JAN HELGE NESBØ		FITJAR KOMMUNE		Erstatter for		
5519 FITJAR		Plan og utvikling		GMR./ BNR. 79/14		
Henvielse		Beregning		Erstatter av		
				HOVEDETASJE		
				Fluavn		

BRA	3090	BTA	1760	KVM	BYA	2370	KVM
UNDERETASJE	1130						
HOVEDETASJE	1240						
LOFT	720						
TOTALT	3090	BTA	1760	KVM	BYA	2370	KVM



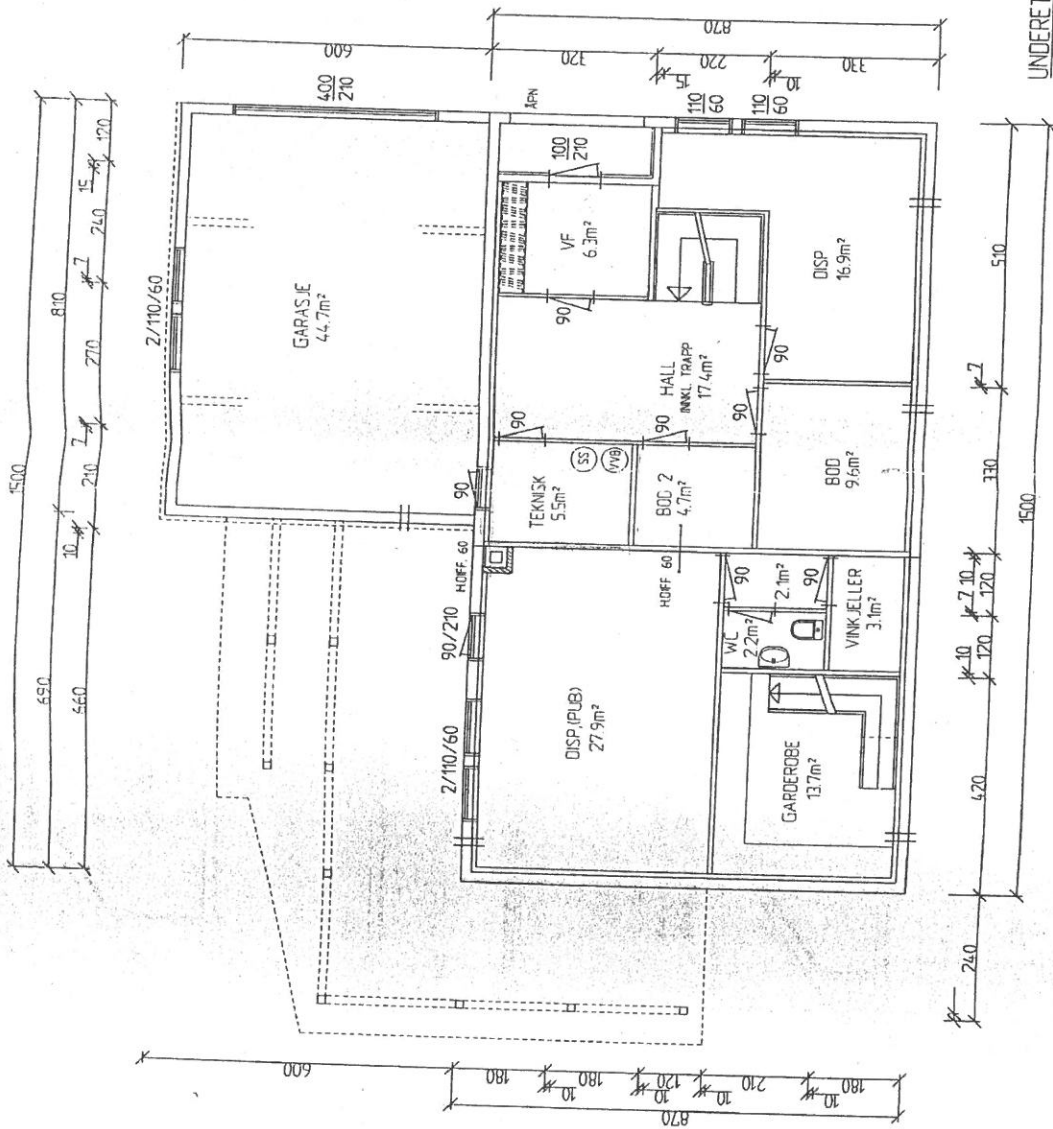

UNDERETASJE

REV.15/03-05

Dato	12/01-05	Konstr./Tegetr	EK/IG	Trætt	Målestokk	1:100
Kont.	ESKILD	Stadl. kontr.		Godejant		
JAN HELGE NESBØ		FITJAR KOMMUNE		Erstatning for		
5519 FITJAR		Plan og utvikling		GNR./ BNR. 79/10		
Hensving		Beregning		Erstatlet av		
				UNDERETASJE		
				Feltavn		

BRA	3090
UNDERETASJE	1130
HØVEDETASJE	1240
LOFT	720
TOTALT	3090

BTA = 1760 KVM BYA = 2370 KVM

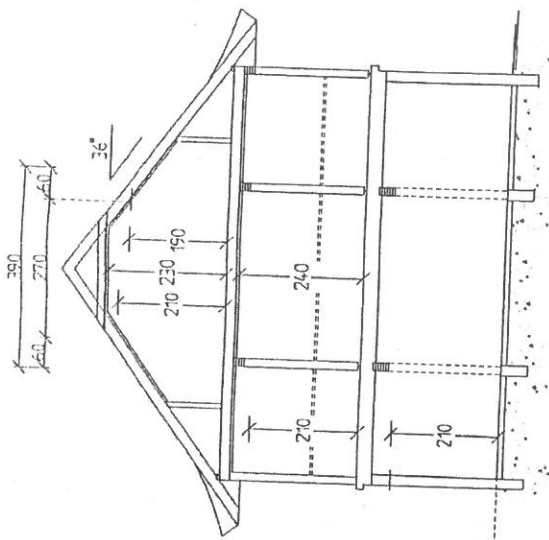

SNITT, GARASJE/UTEPLASS

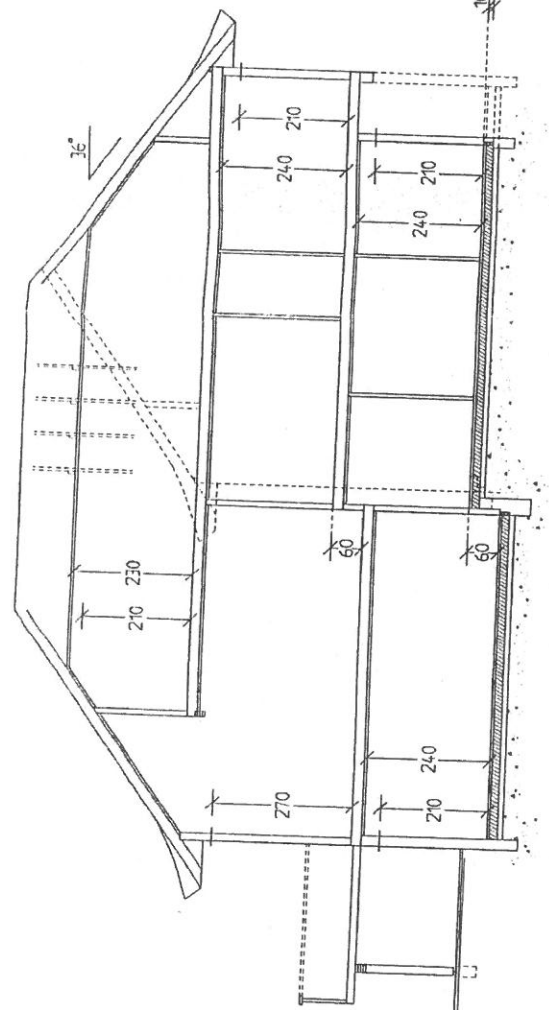

SNITT, STUE/KJØKKEN

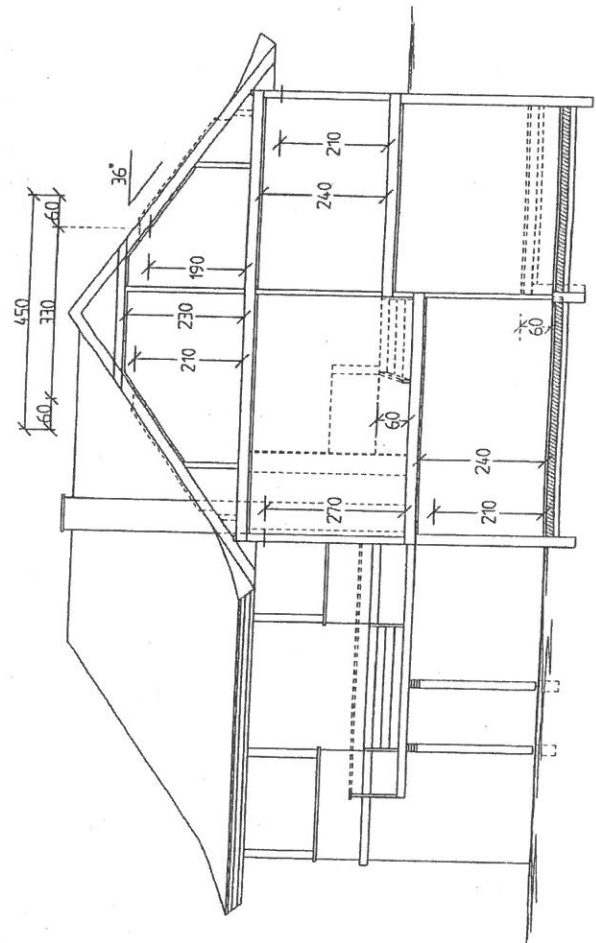

SNITT, STUE/SOVE

REV.15/03-05

Dato 12/01-05	Konstr./Tegnel EK/LG	Tracel	Målestokk 1:100	GNR./ BNR. 79/10
	Konstr. ESKILD			
JAN HELGE NISSØ 5519 FITJAR			FITJAR KOMMUNE Plan og utvikling	
Hensøking			Beregning	Erstatning for
			SNITT	
			Plannr	

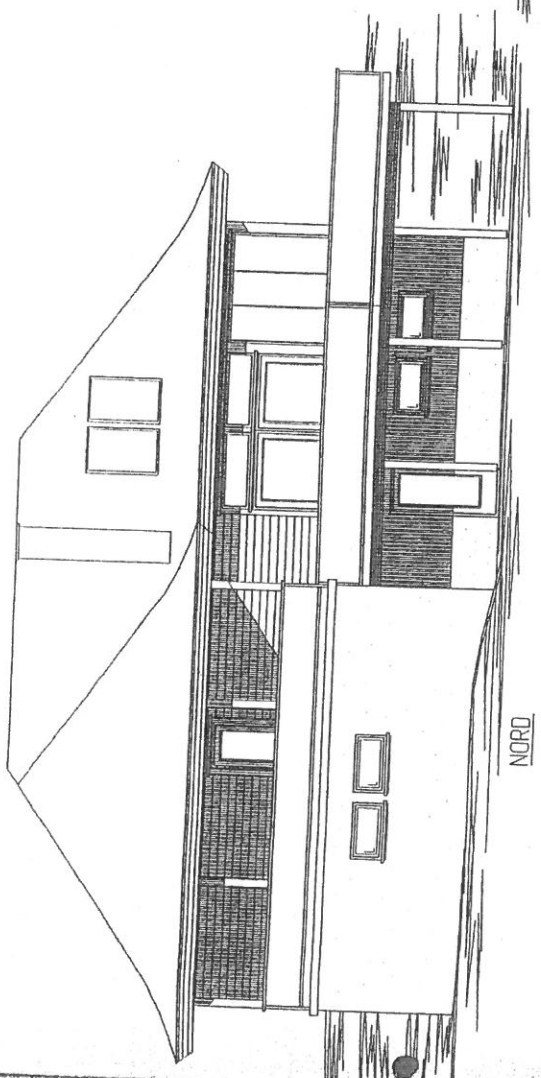

NORD

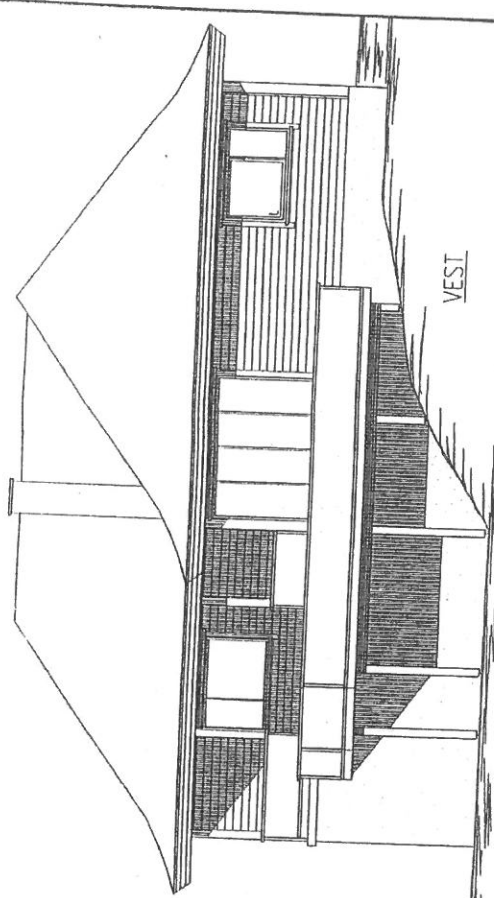

VEST

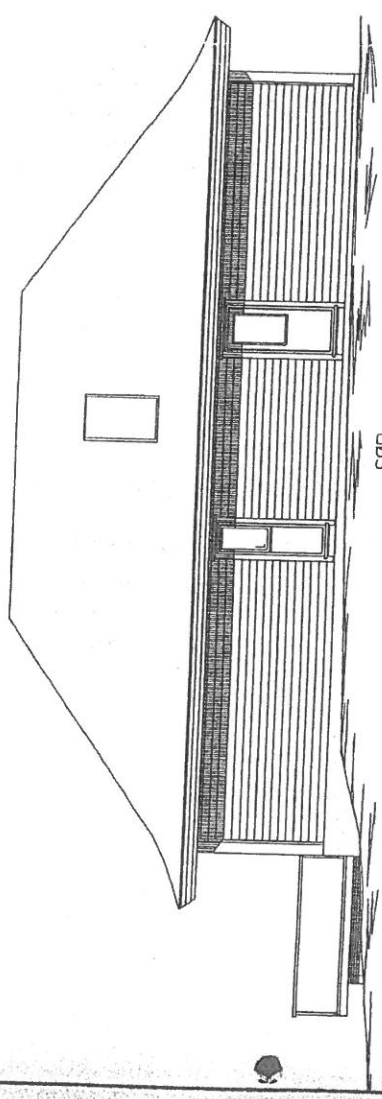

SØR

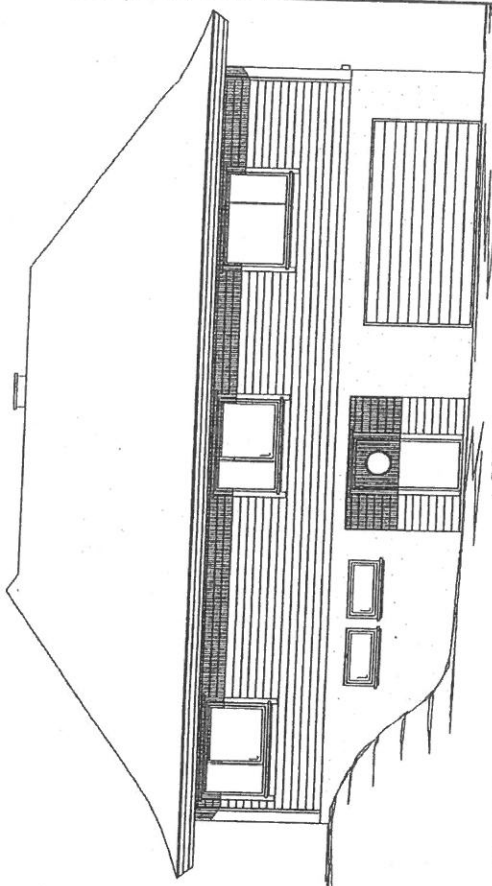

ØST

REV/15/03-05

Dato 12/01-05	Konstr./Tegner EK/IG	Tracé	Målestokk 1:100
Kontr. ESKILD	Stand. kontr.	Godkjent	
JAN HELGE NESBØ		FITJAR KOMMUNE Plan og utvikling	
5519 FITJAR		Erstatning for	
Henvielse		Erstatter av	
		GNR./ BNR. 79/10	
		FASADER	
		Fôravn	
		Beregning	