

Fasade mot

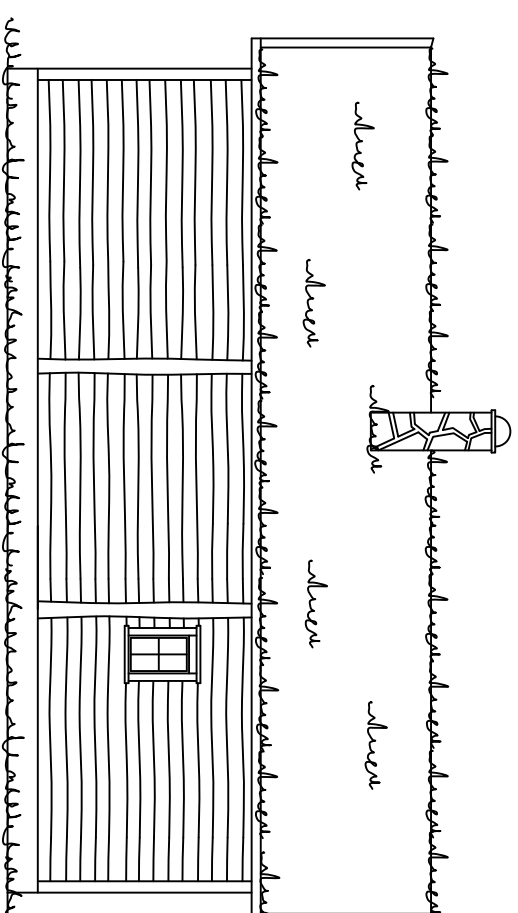

Fasade mot

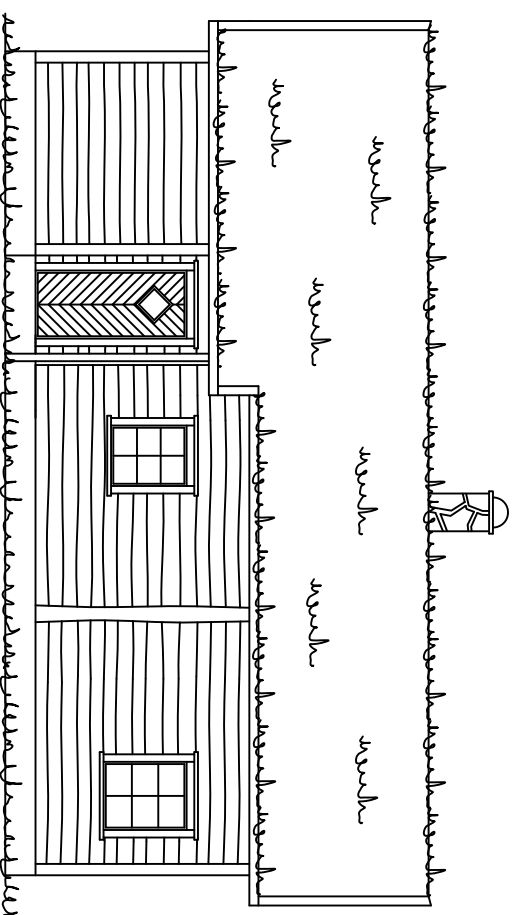

Fasade mot

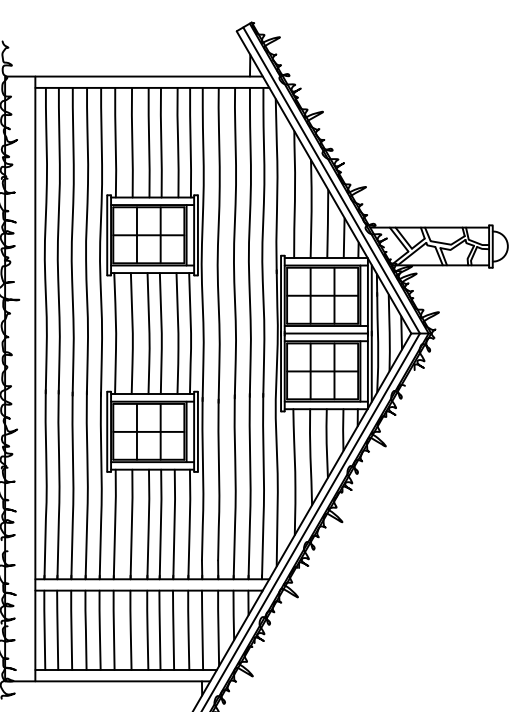

Fasade mot



4540 ASERAL

Tlf : 38283800 Fax : 38283801

Tlf : Raymond 90752181

Tlf : Eivind 91564829

Mail : raymond@aseralhytter.no

Mail : eivind@aseralhytter.no

Byggherre : **Fritidsbygg AS**

Prosjekt : Fritidsbolig

Byggeplass : Bortelid Kommune : Aseral

Type tegning : Fasade

Tegningsnr : Vella 32B Målestokk : 1:100

Tegnet av : R. S Dato : 11.08.2017

Andre opplysninger :

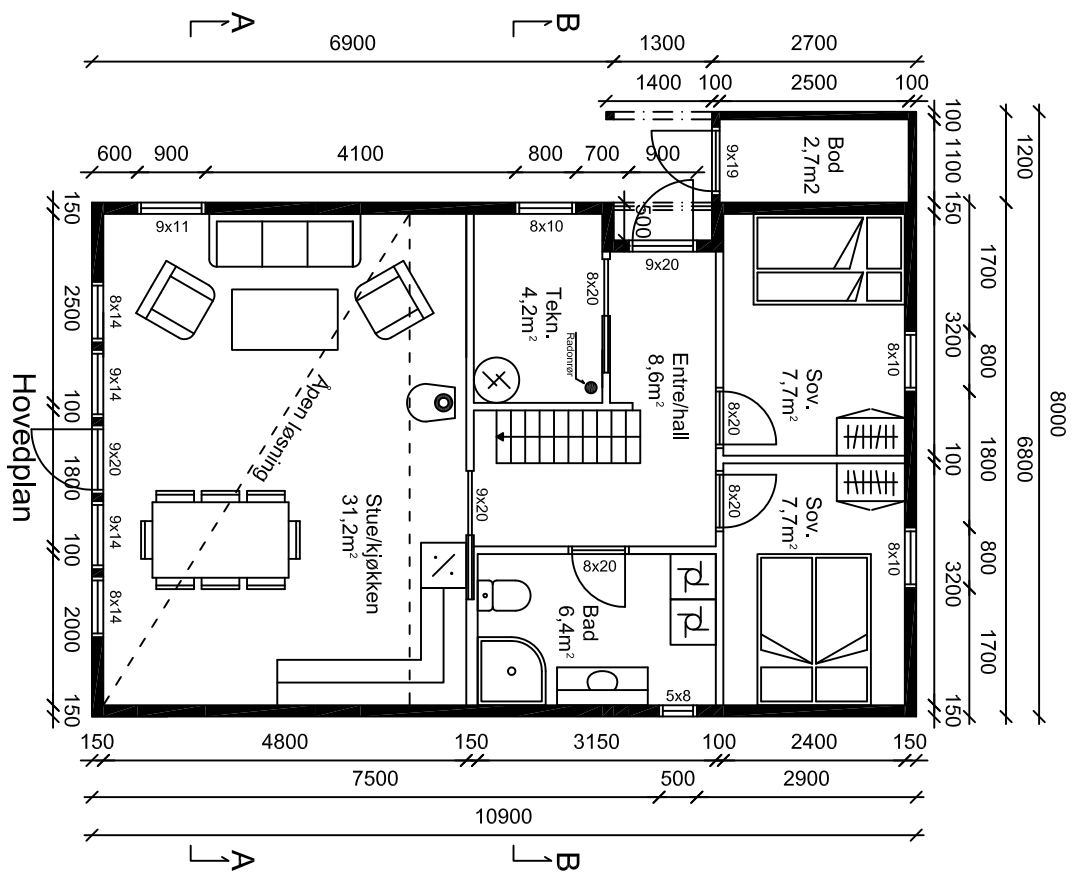
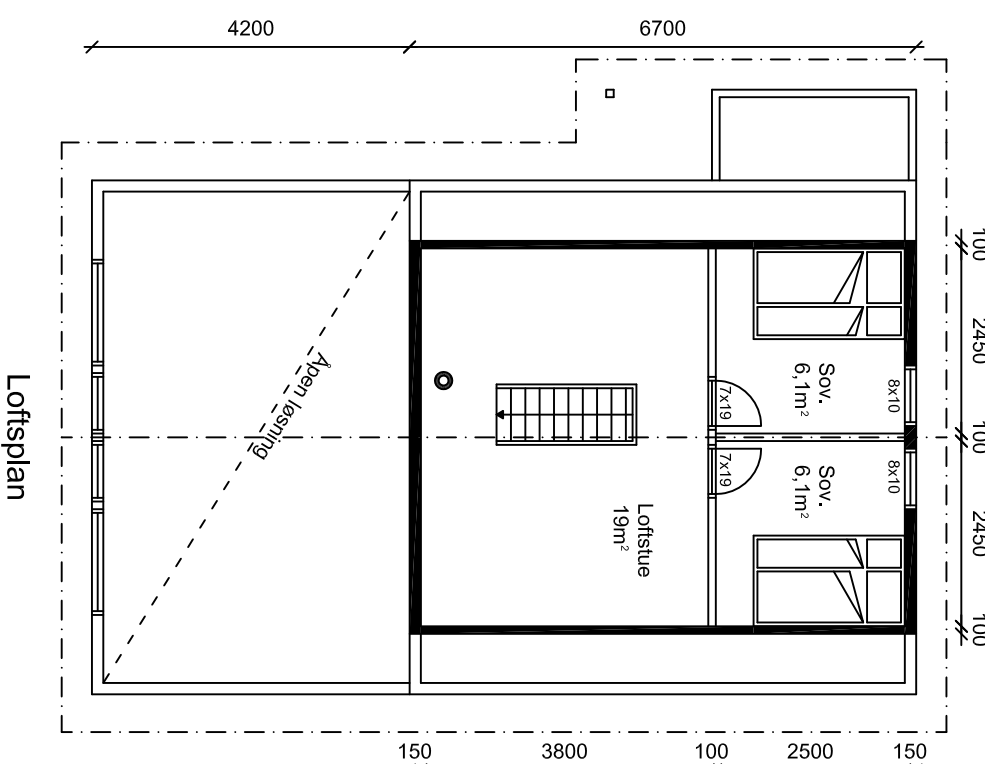
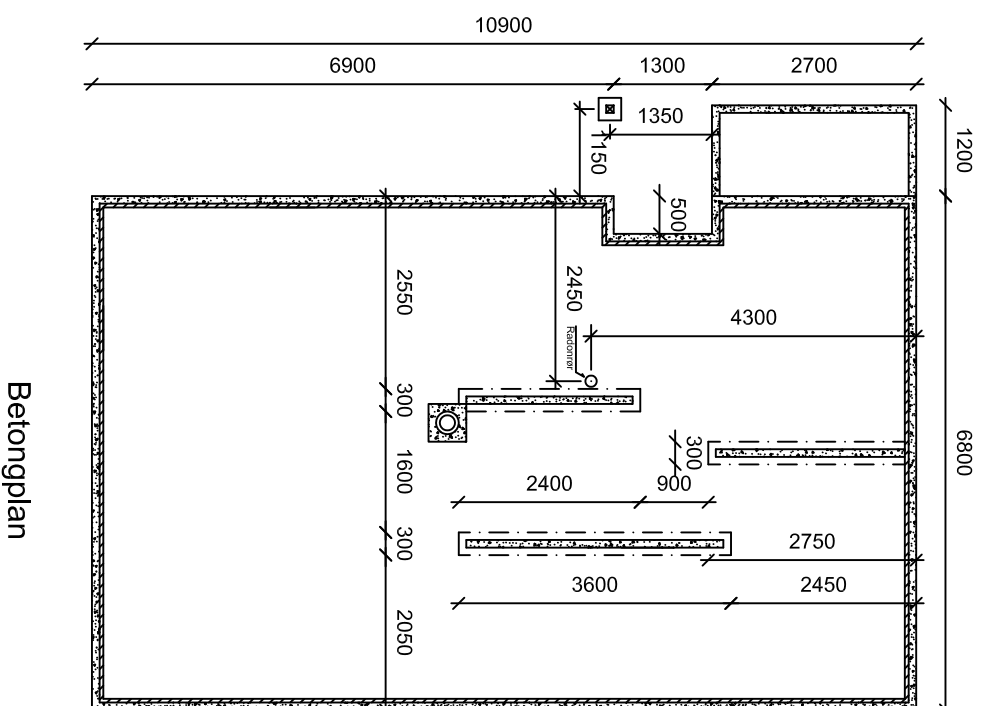

Grunnflate: 76,7m<sup>2</sup>  
 BYA: 79m<sup>2</sup>  
 BRA: 94,8m<sup>2</sup>

Betongplan

Loftsplan

Hovedplan

Tegninger må ikke kopieres eller delvis kopieres uten samtykke med Aseral Hytter

		Byggherre :	Fritidsbygg AS
		Prosjekt :	Fritidspolig
4540 ASERAL		Byggeplass :	Bortelid
Tlf : 38283800 Fax : 38283801		Type tegning :	Plan
Tlf : Raymond 90752181		Tegningsnr :	Vella 32B
Tlf : Eivind 91564829		Tegnet av :	R. S
Mail : raymond@aseralhytter.no		Andre opplysninger :	
Mail : eivind@aseralhytter.no		Kommune :	Aseral
		Gnr. Bnr :	
		Målestokk :	1:100
		Dato :	11.08.2017

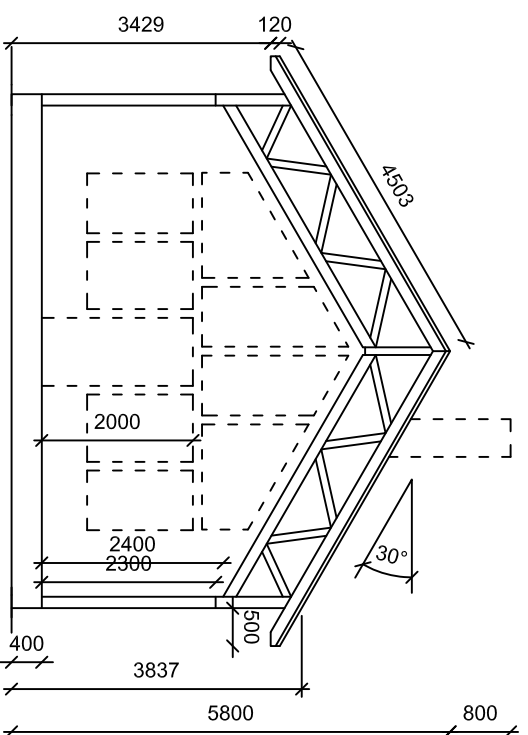

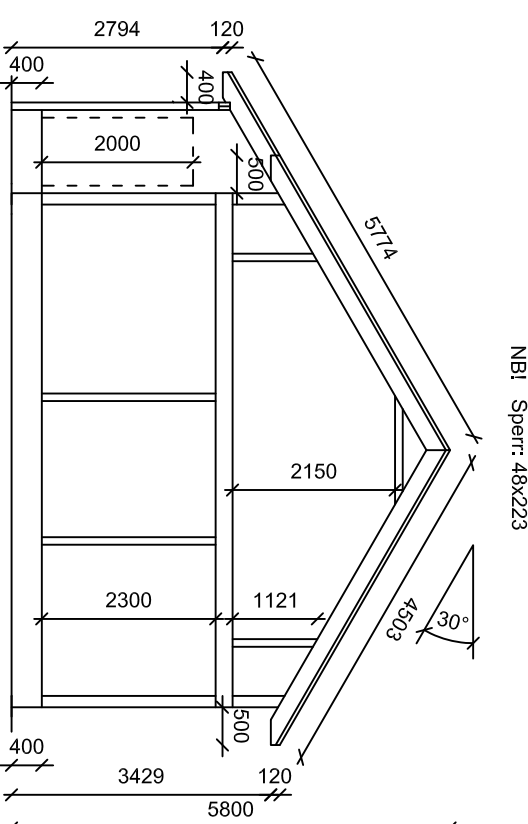

Snitt A - A

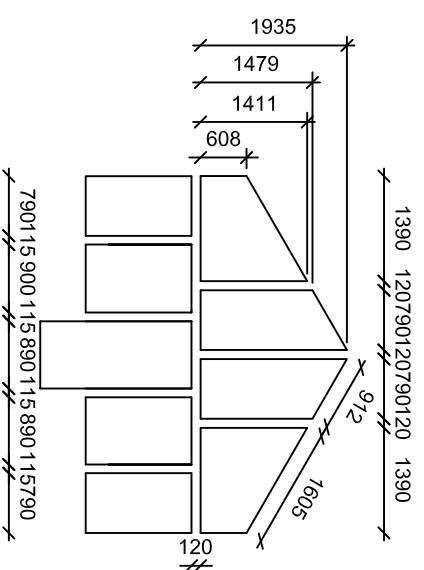

Snitt B - B

NB! Sperr: 48x223



	
<b>4540 ASERAL</b>	
Tlf : 38283800 Fax : 38283801	
Tlf : Raymond 90752181	
Tlf : Eivind 91564829	
Mail : raymond@aseralhytter.no Mail : eivind@aseralhytter.no	
Byggherre :	<b>Fritidsbygg AS</b>
Prosjekt :	Fritidsbolig
Byggeplass :	Bortelid
Type tegning :	Snitt
Tegningsnr :	Vella 32B
Tegnet av :	R. S
Andre opplysninger :	
Kommune :	Aseral
Gnr. Bnr :	
Målestokk :	1:100
Dato :	11.08.2017